

BLACK 10

10" 2-WAY 2400 WATT LOUDSPEAKER WITH WIRELESS CONNECTIVITY
TECHNICAL SPECIFICATIONS



BLACK 10

10" 2-WAY 2400 WATT LOUDSPEAKER WITH WIRELESS CONNECTIVITY

Designed and tuned in the USA, Black Series 2-way active loudspeakers offer more power, more agility, and more intelligence than any other speaker in their class.

Power for the Black 10 comes from an efficient Class D amplifier capable of producing 1200 Watts of continuous power, with a dynamic/peak power rating of 2400 Watts. The optimized HF waveguide provides an effective 90° x 60° coverage field.

The cabinet features sturdy plywood construction with an anti-scuff coating. The steel grille is finished in a professional-grade powder coating. A custom-molded handle allows easy transport. Steel-reinforced rubber feet provide excellent stability. The Black 10 offers feet on two sides, for vertical or horizontal use. A pole-mount socket (35mm) is fitted into every model. Standard M10 rigging points allow the Black 10 to be flown. The illuminated logo nameplate can be switched off for more discreet installations.

The Black 10 features two XLR+1/4" combo inputs offering individual level controls, and Input 1 is equipped with a Mic/Line switch. The single XLR Mix Output can be set for Pre or Post level controls. The internal DSP EQ can be accessed directly from the rear panel or Live Drive app. All models include a ground lift switch to minimize any unexpected ground loop hum at the venue.

Live Drive is the wireless remote control app available for iPhone, iPod touch, and iPad. Available at the App Store, Live Drive for the Alto Professional Black Series provides remote wireless control over the internal DSP/EQ, Delay-Compensation, Level and Mute status. The Live Drive app allows each Black Series loudspeaker and subwoofer to be quickly re-adjusted at any time, and from any location to assure peak performance in every venue.



FEATURES

- 1200 Watts continuous (2400 Watts peak)
- 10" LF transducer, 1.75" HF driver with 1" exit
- 2 combo inputs with independent volume controls, and Mic/Line switch on Channel 1
- XLR output to link speakers
- Lightweight, trapezoidal cabinet with handle
- 90° x 60° coverage field
- Stand-/pole-mountable or flyable
- Limit/Clip indicator with red LED
- Ground lift switch
- DSP mode switch for increased EQ control
- Accurate audience coverage, even off-axis
- Designed and tuned in the USA

SPECIFICATIONS

<p>SYSTEM CONFIGURATION:</p> <p>System Type: 10" two-way, self-powered, Horn-loaded HF</p>	<p>AC LINE POWER:</p> <p>Power Supply Design: Fully regulated switching, with Power Factor Correction</p> <p>Input Voltage Nominal Range: 100 – 240 VAC, 50/60 Hz</p> <p>Input Voltage Operating Range: 90 – 264 VAC, 50/60 Hz</p> <p>Voltage Selection: Automatic (self-regulating)</p> <p>Power Connector: Male IEC</p> <p>Current Requirement: 6 A per system @ 120 VAC. 3 A per system @ 240 VAC</p> <p>AC Line Cord: 9.8' (3m) IEC female to regional AC male, 18 AWG.</p>
<p>ACOUSTIC PERFORMANCE</p> <p>Frequency Range (-10 dB): 45 Hz – 20 kHz</p> <p>Frequency Response (+/-3 dB): 51 Hz – 20 kHz</p> <p>Maximum Peak SPL (Measured): 131 dB @ 1 m</p> <p>Coverage Pattern (Averaged): 90° H x 60° V</p> <p>Directivity Index (D.I.): 9.5 dB</p>	<p>CONNECTORS AND CONTROLS:</p> <p>Input Connectors: 2 x XLR/TRS combo connectors, balanced</p> <p>Input Impedance: 10 KΩ balanced, 20 KΩ unbalanced</p> <p>Input level Controls: 2 x rotary volume control</p> <p>Acoustic Polarity: Positive voltage applied to XLR Pin 2 generates positive pressure from LF driver</p> <p>Line/Mic Level Selector: Push-button switch (applies to Input 1 only)</p> <p>Output Connector: Male XLR</p> <p>Output Mix Control: Switch to select output mix pre- or post-volume control</p> <p>Ground Switch: Push-button to lift input signal input ground connection</p> <p>Bluetooth: Momentary contact to initiate Bluetooth pairing mode</p> <p>DSP Mode Selection: Momentary contact to cycle through DSP EQ modes</p> <p>DSP Modes Available: 5 total: Flat, Contour, 80 Hz HP, EXT LF, User</p> <p>DSP Wireless Control: Alto Professional Live Drive™ iOS app over Bluetooth</p> <p>Grille Logo LED On/Off Control: Recessed push-button switch</p> <p>Standby Mode On/Off Control: Recessed push-button switch</p> <p>LED Indicators: Signal Present / Limit, Power / Standby</p> <p>Line Input Level Control Range: -∞ to 0 dB, +4 dBu nominal, +10 dBu for max output</p> <p>Mic Level Control Range: -∞ to +50 dB</p>
<p>POWER AMPLIFICATION:</p> <p>Peak Power: 2400 Watts (1600 Watts LF + 800 Watts HF)</p> <p>Continuous Power: 1200 Watts (800 Watts LF + 400 Watts HF)</p> <p>Amplifier Topology: Class D / Switching, Bridged LF and HF</p> <p>Amplifier Cooling: Passive</p>	<p>ENCLOSURE:</p> <p>Construction: 15mm and 18mm premium plywood</p> <p>Finish: High-durability, textured, catalyzed polyurethane, black</p> <p>Mounting: 12 x M10 female threaded screw sockets</p> <p>Handles: Ergonomic handle with aluminum cross-bar</p> <p>Stand mount: 1 x 35 mm female socket</p> <p>Grille: 1.2mm-thick perforated steel, black powder-coat</p> <p>Operating Temperature: -10°C to 40°C (14°F to 104°F)</p> <p>Dimensions (H x W x D): 560mm x 330mm x 344mm (22.0" x 13.0" x 13.5")</p> <p>Net Weight: 20.7 kg (45.7 lbs)</p>
<p>TRANSDUCER:</p> <p>LF Transducer: 10" (300mm) cone transducer, 2.5" (65mm) voice coil, ferrite magnet</p> <p>HF Transducer: 1.75" (44mm) voice coil, ferrite magnet compression driver with 1" (25mm) exit</p>	
<p>DSP FUNCTIONALITY:</p> <p>System Control: high-pass & low-pass crossover filters, transducer EQ and delay-compensation, transducer excursion, thermal, and amplifier clip protection.</p> <p>User Controls: Rear panel selection of 5 DSP EQ modes: Flat, Contour, 80 Hz HP, EXT LF, User</p>	
<p>WIRELESS CONTROL AND MONITORING:</p> <p>Wireless Type: Bluetooth 2.0 + EDR. Class 2 RF</p> <p>Wireless Range (typical): 82' (25m) clear line-of-sight.</p> <p>Wireless Control App: Alto Professional Live Drive™ (Available at the Apple App Store)</p> <p>Simultaneous Devices Connectable: 1 to 3 Black Series loudspeakers</p> <p>Compatible Wireless Devices: iPhone 3GS and newer, iPad 2 and newer, iPod touch (4th generation) and newer</p> <p>iOS Version Requirements: iOS 6.1 and newer</p> <p>Wireless Control Features: Level Control (-∞ to + 10 dB), Mute, Signal level metering (-70 to 0 dB) DSP mode (Flat, Contour, 80 Hz HP, Ext. LF, User) Rear Panel control lockout, 3 Band EQ (Low, Mid, High), Delay, Polarity, User high-pass filter, Monitoring (Limit, Peak, Fault)</p>	

PHYSICAL PROPERTIES

Height	560mm (22.0")
Width	330mm (13.0")
Depth	344mm (13.5")
Net Weight	20.7 kg (45.7 lbs)

560mm
(22.0")

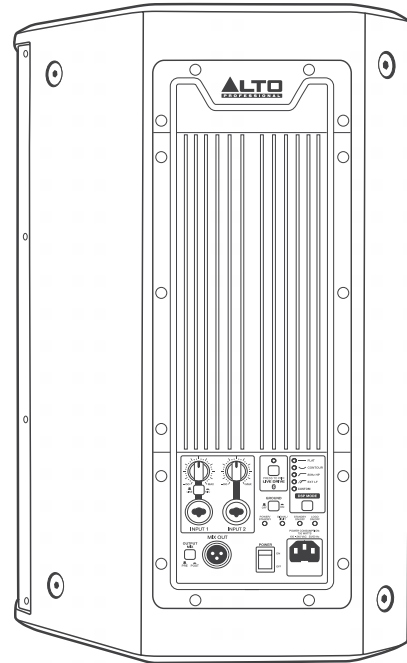
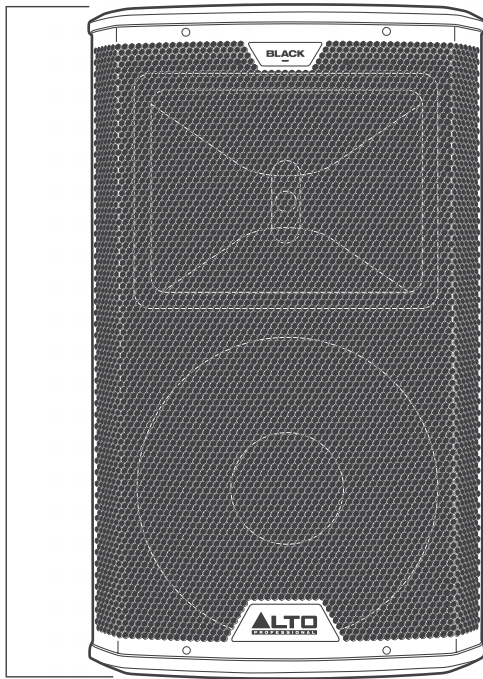

344mm
(13.5")

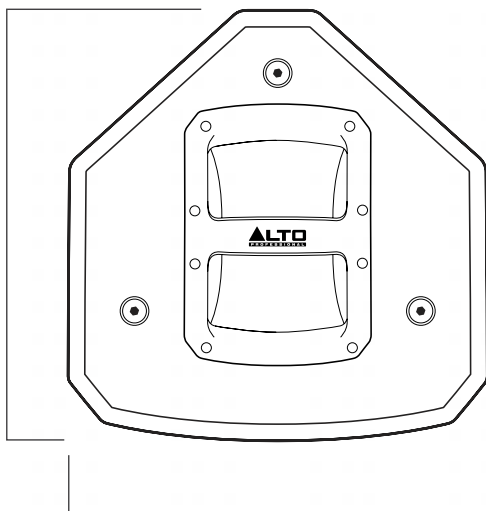

330mm
(13.0")

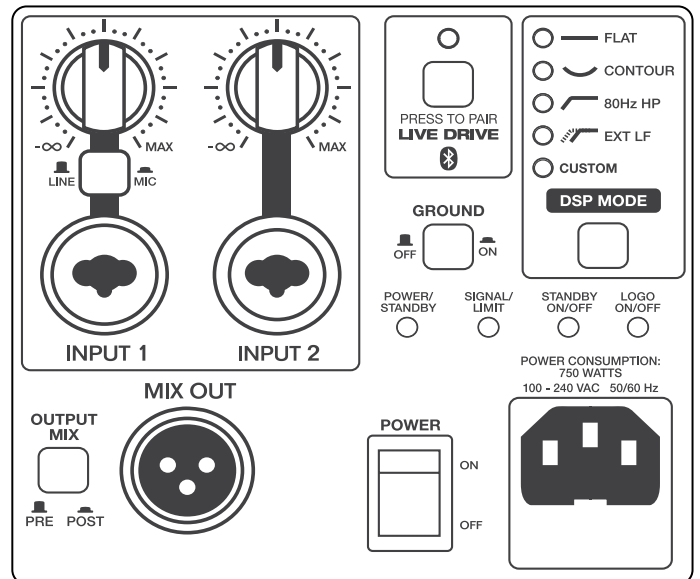

FREQUENCY RESPONSE ON-AXIS

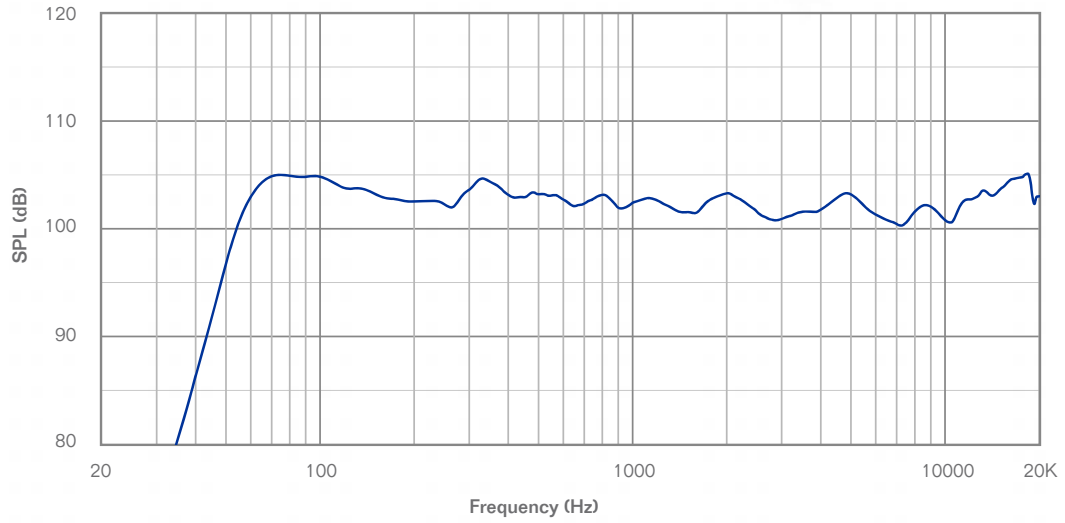

BEAMWIDTH VS. FREQUENCY

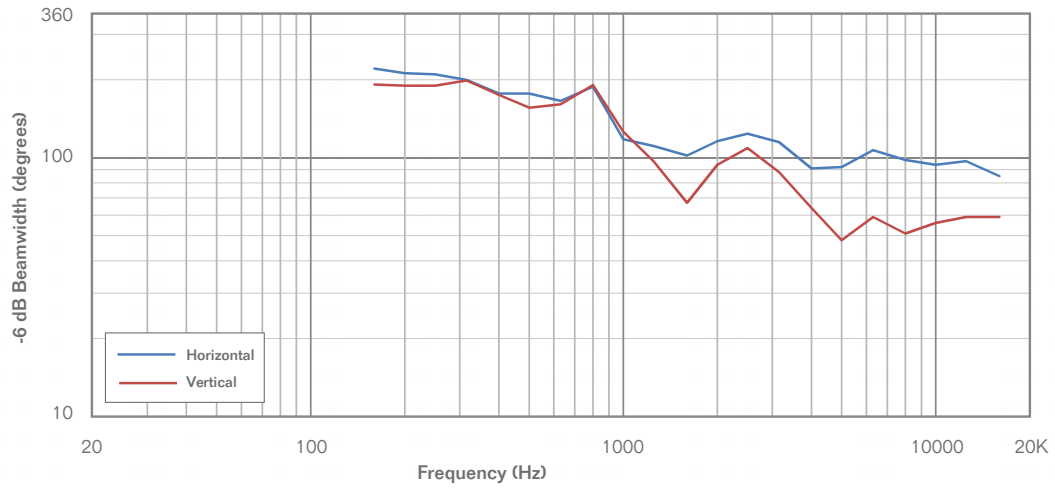

DIRECTIVITY VS. FREQUENCY

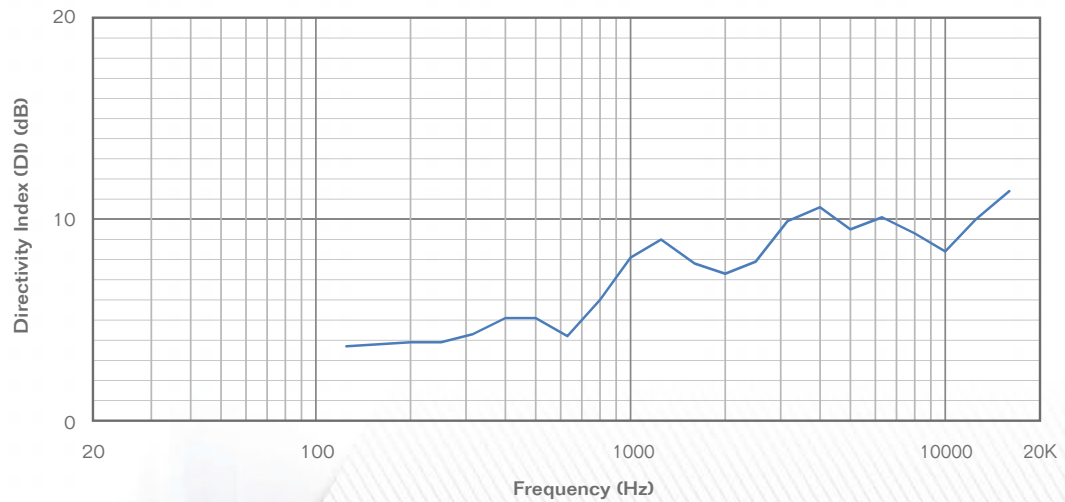

HORIZONTAL OFF-AXIS FREQUENCY RESPONSE

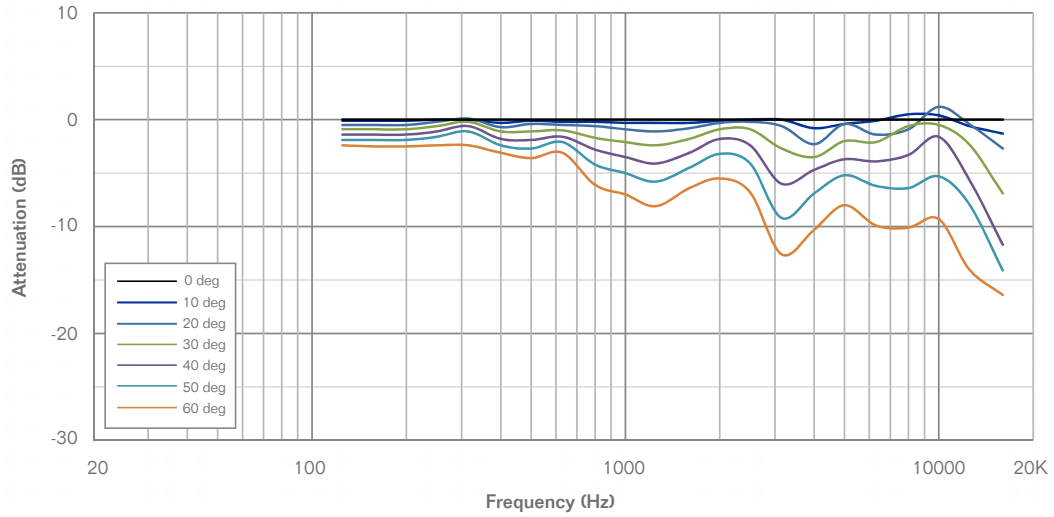

VERTICAL UP OFF-AXIS FREQUENCY RESPONSE

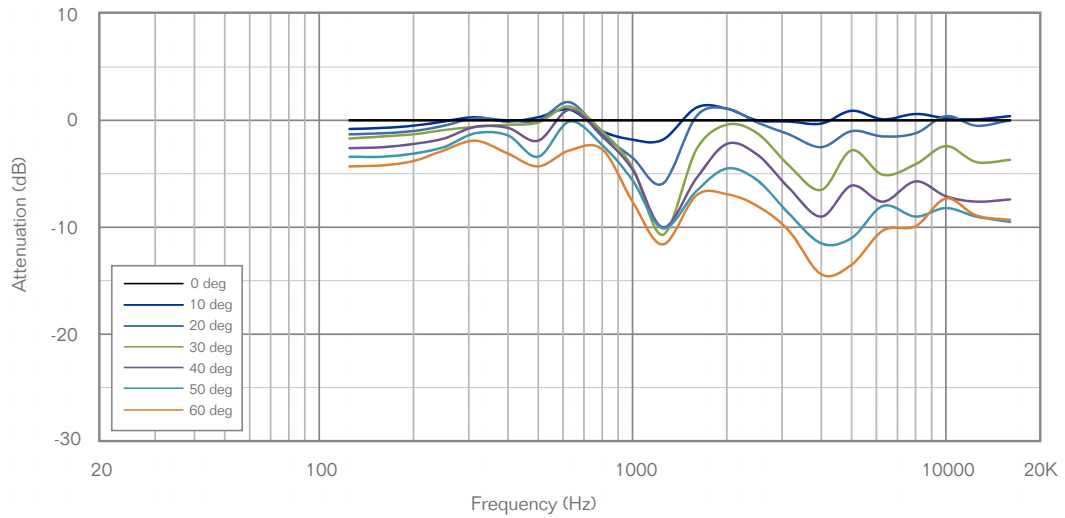

VERTICAL DOWN OFF-AXIS FREQUENCY RESPONSE

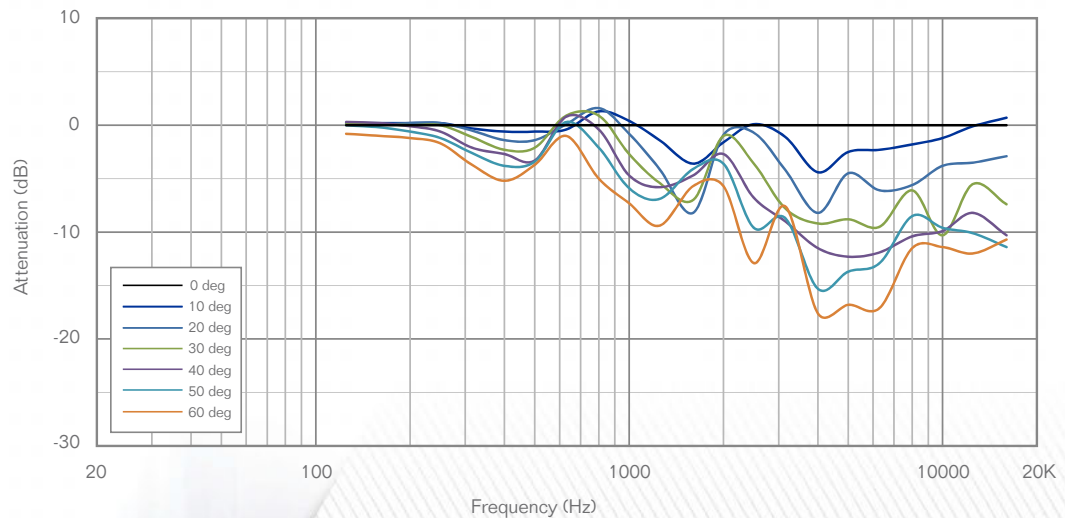

POLAR PATTERNS

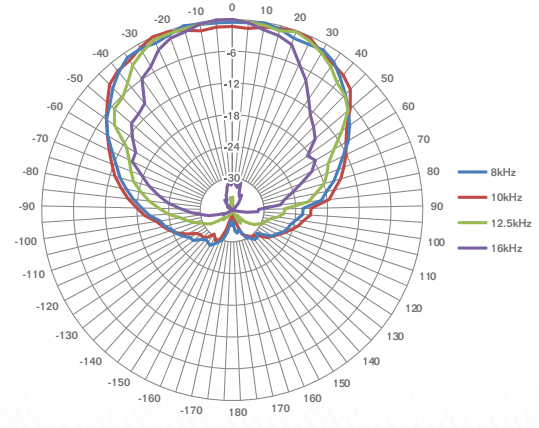
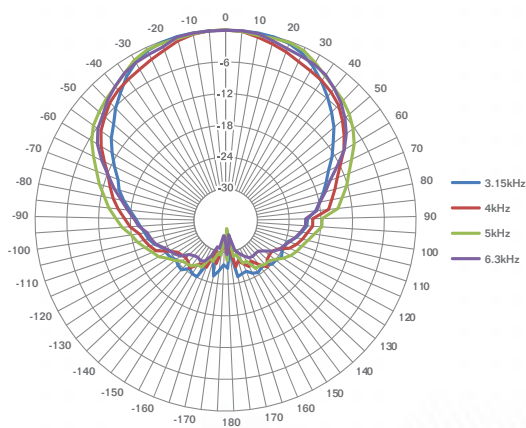
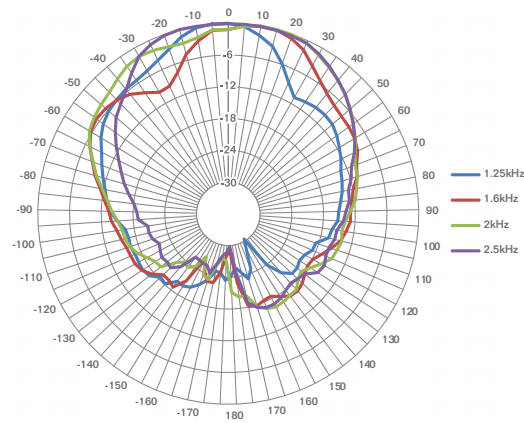
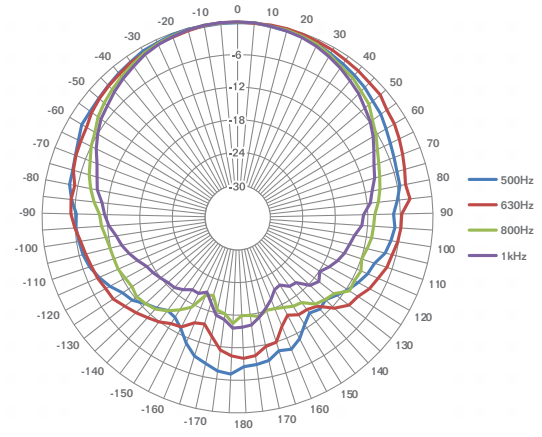
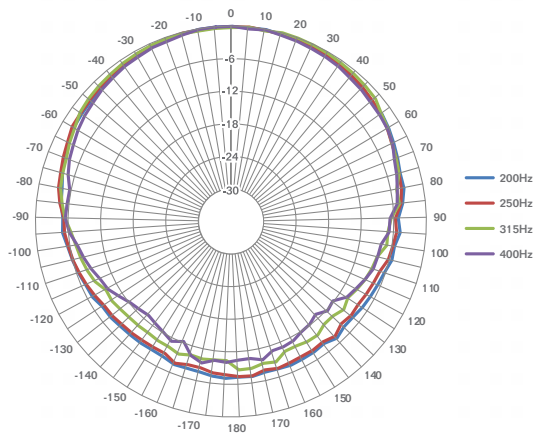

POLAR PATTERNS

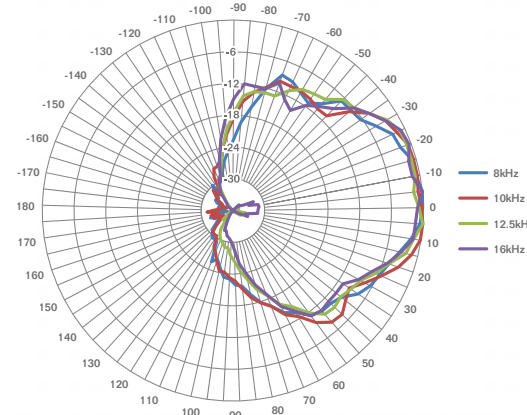
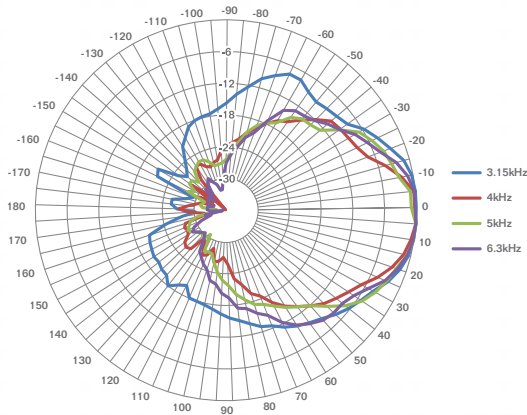
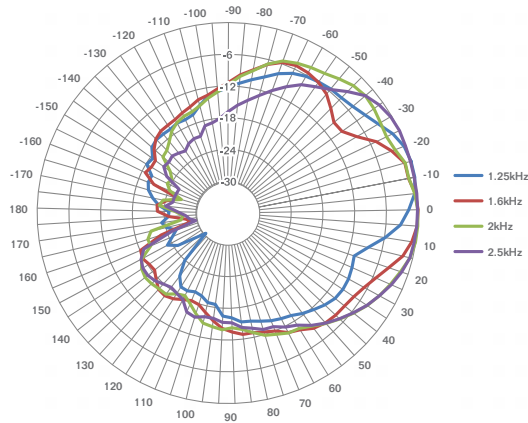
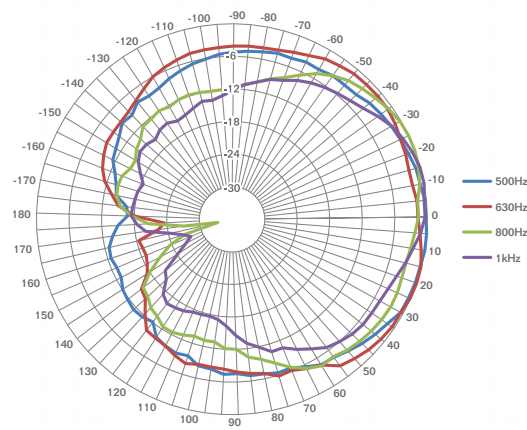
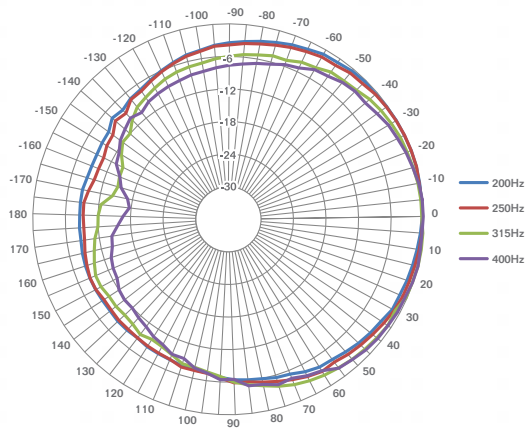



BLACK 10



USA | WORLD HEADQUARTERS

200 Scenic View Drive
Cumberland, RI
02864
USA
Tel: 401.659.8135
Fax: 401.658.3640

UNITED KINGDOM

Unit 3, Nexus Park
Lysons Avenue
Ash Vale
HAMPSHIRE
GU12 5QE
ENGLAND
Tel: +44.1252.896000
Fax: +44.1252.896021

GERMANY | WILlich

Halskestr. 16-18
47877 Willich
GERMANY
Tel: +49.2154.812990
Fax: +49.2154.812999

GERMANY | BREMEN

Osterstr. 28/29
D-28199 Bremen
GERMANY
Tel: +49.421.16039-001

BRAZIL

RUA General Flores,
290 - cj 134/135
Bom Retiro
São Paulo — SP
01129-010
BRAZIL
Tel: +551132234820
Fax: +551133370579

PERU

437 Av. Larco
Miraflores
Lima 18
PERU
Tel: +51981096189
Fax: 401.223.6767

JAPAN

6F, 3-19-23, Minami-Azabu
Minato-ku, Tokyo
106-0047
JAPAN
Tel: +81.3.6277.2230
Fax: +81.3.6277.0025

TAIWAN

7F, #165, Nanking East Road, Sec. 4,
Taipei 105
TAIWAN
Tel: 886.2.2717.2389
Fax: 88 6.2.2717.2734