

User's Manual

X23SW

2-WAY STEREO
CROSSOVER PLUS SUBWOOFER



www.altoproaudio.com
Version 1.2 September 2005

— English —

SAFETY RELATED SYMBOLS



This symbol, wherever used, alerts you to the presence of un-insulated and dangerous voltages within the product enclosure. These are voltages that may be sufficient to constitute the risk of electric shock or death.



This symbol, wherever used, alerts you to important operating and maintenance instructions. Please read.



Protective Ground Terminal



AC mains (Alternating Current)



Hazardous Live Terminal

ON: Denotes the product is turned on.

OFF: Denotes the product is turned off.

WARNING

Describes precautions that should be observed to prevent the possibility of death or injury to the user.

CAUTION

Describes precautions that should be observed to prevent damage to the product.



Disposing of this product should not be placed in municipal waste and should be Separate collection.

WARNING

• Power Supply

Ensure that the mains source voltage (AC outlet) matches the voltage rating of the product. Failure to do so could result in damage to the product and possibly the user.

Unplug the product before electrical storms occur and when unused for long periods of time to reduce the risk of electric shock or fire.

• External Connection

Always use proper ready-made insulated mains cabling (power cord). Failure to do so could result in shock/death or fire. If in doubt, seek advice from a registered electrician.

• Do Not Remove Any Covers

Within the product are areas where high voltages may present. To reduce the risk of electric shock do not remove any covers unless the AC mains power cord is removed.

Covers should be removed by qualified service personnel only.

No user serviceable parts inside.

• Fuse

To prevent fire and damage to the product, use only the recommended fuse type as indicated in this manual. Do not short-circuit the fuse holder. Before replacing the fuse, make sure that the product is OFF and disconnected from the AC outlet.

• Protective Ground

Before turning the product ON, make sure that it is connected to Ground. This is to prevent the risk of electric shock.

Never cut internal or external Ground wires. Likewise, never remove Ground wiring from the Protective Ground Terminal.

• Operating Conditions

Always install in accordance with the manufacturer's instructions.

To avoid the risk of electric shock and damage, do not subject this product to any liquid/rain or moisture. Do not use this product when in close proximity to water.

Do not install this product near any direct heat source.

Do not block areas of ventilation. Failure to do so could result in fire.

Keep product away from naked flames.

IMPORTANT SAFETY INSTRUCTIONS

Read these instructions

Follow all instructions

Keep these instructions. Do not discard.

Heed all warnings.

Only use attachments/accessories specified by the manufacturer.

• Power Cord and Plug

Do not tamper with the power cord or plug. These are designed for your safety.

Do not remove Ground connections!

If the plug does not fit your AC outlet seek advice from a qualified electrician.

Protect the power cord and plug from any physical stress to avoid risk of electric shock.

Do not place heavy objects on the power cord. This could cause electric shock or fire.

• Cleaning

When required, either blow off dust from the product or use a dry cloth.

Do not use any solvents such as Benzol or Alcohol. For safety, keep product clean and free from dust.

• Servicing

Refer all servicing to qualified service personnel only.

Do not perform any servicing other than those instructions contained within the User's Manual.

Preface

Dear Customer:

Thanks for choosing ▲LTO Active Crossover and thanks for choosing the one of results of ▲LTO AUDIO TEAM job and researches.

For our ▲LTO AUDIO TEAM, music and sound are more than a job...are first of all passion and let us say...our obsession!

We have been designing professional audio products for a long time in cooperation with some of the major brands in the world in the audio field.

The ▲LTO line presents unparalleled analogue and digital products made by Musicians for Musicians in our R&D Centres in Italy, Netherlands, United Kingdom and Taiwan. The core of our digital audio products is a sophisticated DSP (Digital sound processor) and a large range of state of the art algorithms which have been developed by our Software Team for the last 7 years.

Because we are convinced you are the most important member of ▲LTO AUDIO TEAM and the one confirming the quality of our job, we'd like to share with you our work and our dreams, pay attention to your suggestions and your comments.

Following this idea we create our products and we will create the new ones! From our side, we guarantee you and we will guarantee you also in future the best quality, the best fruits of our continuous researches and the best prices.

Our ▲LTO Active Crossover is the result of many hours of listening and tests involving common people, area experts, musicians and technicians.

The results of this effort is an efficient and effective electronic crossover solution, which will give you precise control and superior sound from your loudspeaker system.

Nothing else to add, but that we would like to thank all the people that made the ▲LTO Active Crossover a reality available to our customers, and thank our designers and all the ▲LTO staff, there to make possible the realization of products containing our idea of music and sound and there to support you, our customers, in the best way, conscious that you are our best richness.

Thank you very much.

▲LTO AUDIO TEAM

TABLE OF CONTENTS

1. INTRODUCTION	4
2. FEATURE LIST	4
3. CONTROL ELEMENTS.....	4
3.1 The Front Panel	
3.2 The Rear Panel	
4. INSTALLATION & CONNECTION	5
4.1 Mains Connection	
4.2 Audio Connection	
4.3 Rack Mounting	
5. APPLICATION.....	7
5.1 X23SW 2-Way Stereo	
6. TECHNICAL SPECIFICATIONS.....	8
7. WARRANTY	9

1. INTRODUCTION

Thank you very much for expressing your confidence in ▲LTO products by purchasing our X23SW Active crossover. With the X23SW you have acquired an extremely musical and flexible Active Crossover.

The ▲LTO X23SW Active Crossover is a single rack unit, three channels electronic crossover capable of managing the frequency control for stereo 2-way speaker systems. The X23SW Active Crossover is an ideal crossover solution for most small and large PA systems, live sound venues, commercial installations recording studio monitors and DJ set-ups. In addition to its flexibility in configuring to different sound systems, the X23SW Active Crossover has advanced features such as Clip LED Indicators CD Horn Equ,alization, and individual Phase and Mute switches per frequency band.

The X23SW Active Crossover is an effective and efficient electronic crossover solution, which will give you precise control and superior sound from your loudspeaker system.

2. FEATURE LIST

- Single Rack Unit (1U)
- Robust and Compact Design
- Phase Inversion Switches for High Frequency Band
- 30Hz Low Cut for Subwoofer & Low Frequency Band
- Servo-Balanced XLR and Unbalanced 1/4" Inputs/ Unbalanced 1/4" Outputs
- Subwoofer Output
- State-Variable 12dB/Octave (2nd order) Filters
- Top Audio Performances With High Slew Rate Circuitry and over 115dB Dynamic Range for Transparent Sound
- Shielded Internal Power Supply with AC Voltage Selectable (AC95-120V~60Hz or 210-240V~50Hz)
- Manufactured Under ISO9001 Certified Management System

3. CONTROL ELEMENTS

3.1 The Front Panel

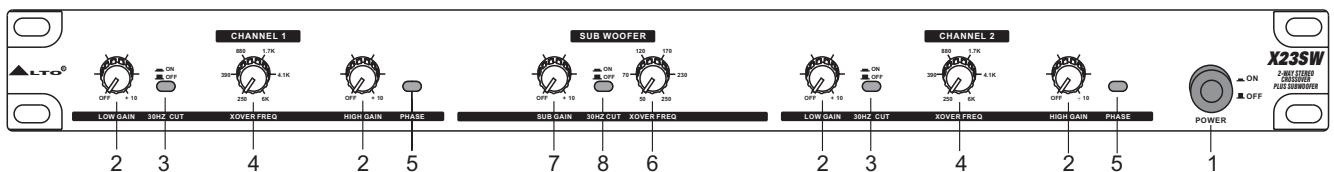

1. Power Switch

This switch powers up and powers down this Crossover.

Caution: Always turns the Crossover on before the amplifier, and turns it off after the amplifier, otherwise, transients harmful to the speakers may result.

2. L/H Output Level Controls

These controls are used to adjust the output level of each Frequency Band: Low and High.

3. 30Hz Low Cut Switches

These inserted 30Hz Low Cut filters in the Low Frequency Band of each channel with a 12dB/Octave, are used to minimize problems from subsonic frequencies in the signal, to suppress Hum noise, and to prevent any low frequency speaker resonance.

4. Crossover Frequency Controls

These controls select the crossover frequencies of the Low and High Frequency Band. They present with a Low cut for the High Frequencies and a High cut for the Low frequencies, you can select the crossover Frequencies between 250Hz and 6kHz.

5. Phase Switches

These allow switching the polarity to invert the signal phase in the High Frequency Band. This is done to correct audible phase problems after the output levels being proper adjustment.

Caution: Before pressing the Phase Switches, always lower the outputs of your power amplifier to avoid possible speaker damage.

6. Sub Crossover Frequency Control

This control select the crossover frequencies of the Subwoofer Frequency Band. You can select the crossover frequencies between 50Hz and 250Hz.

7. Subwoofer Output Level Control

This control is used to adjust the output level of the Subwoofer Frequency Band.

8. Subwoofer Low Cut Switch

This inserted 30Hz Low Cut filter in the Subwoofer Frequency Band with a 12dB/Octave, is used to minimize problems from subsonic frequencies in the signal, to suppress Hum noise, and to prevent any low frequency Speaker resonance.

3.2 The Rear Panel

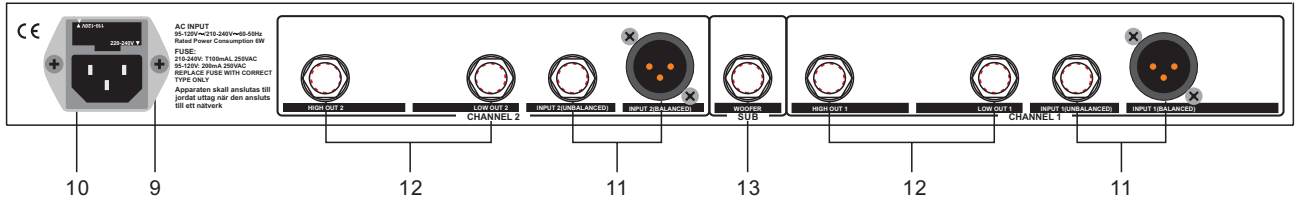

9. Fuse Holder / Voltage Selector

This is a dual voltage unit. Before you attempt to connect and operate the unit, please make sure that your local voltage matches the voltage on the fuse-holder cover.

Caution: The fuse protecting the AC supplies circuits of this unit. The fuse can only be changed by a qualified technician, in the event of a fault or changing the supply voltage. If the fuse continues to blow after replacing, discontinue use of this unit before repaired.

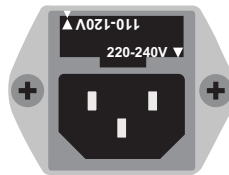

THIS IS SET FOR
110V AC TO 120V
AC OPERATION

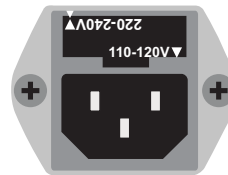

THIS IS SET FOR
220V AC TO 240V
AC OPERATION

The fuse-holder above the AC connector on the rear of the chassis has 3 triangular markers (please refer to the above pictures), with two of these triangles opposing each other, your unit is set to the operating Voltage printed next to these markers.

To change, pull fuse-holder out and rotate 180°, then push in again.

10. AC Inlet

This connector is meant for the connection of the supplied main cord.

Do not insert power cable into unit until voltage has been correctly set. Do not plug power cable into AC power until voltage has been correctly set.

11. Stereo Input Connectors

Connect your L/R stereo input signal to either the balanced XLR or the unbalanced 1/4" input jacks.

12. Output Connectors

Connect to your amplifiers via these unbalanced 1/4" output jacks.

13. Subwoofer Output Connector

Connect your subwoofer amplifier via this unbalanced 1/4" output jacks.

4. INSTALLATION & CONNECTION

4.1 Mains Connection

Please ensure that the ▲LTO X23SW Active Crossover is set to the correct supply voltage before plugging the power cord into the wall outlet, use the same fuse as marked on the fuse holder at the AC power connection socket.

Do not insert power cable into the unit until voltage has been correctly set. Do not plug the power cable into AC power until voltage has been correctly set.

The mains connection of the ▲LTO X23SW Active Crossover is made by using the enclosed mains cable and a standard IEC receptacle. It meets all of the international safety certification requirements.

4.2 Audio Connection

The ▲LTO X23SW Active Crossover presents with balanced XLR and 1/4" TRS connectors, and it can be interfaced by several ways to support a variety of applications without any signal loss.

a. Wiring Configuration

Either the 1/4" TRS (Tip-Ring-Sleeve) jack or the XLR servo connector can be wired in balanced and unbalanced modes. Please wire your systems as the following examples:

• For 1/4" TRS jack

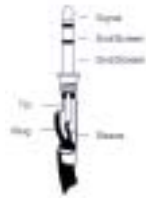

1/4" TRS jack
Unbalanced Input



1/4" TRS jack
Balanced Input

• For XLR Connector

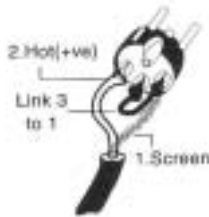

XLR Unbalanced Input



XLR Balanced Input

b. In Line Connection

For these applications, the X23SW Active Crossover provides XLR connectors to easily interface with most professional audio devices. Follow the configuration examples below for your particular connection.

• Balanced

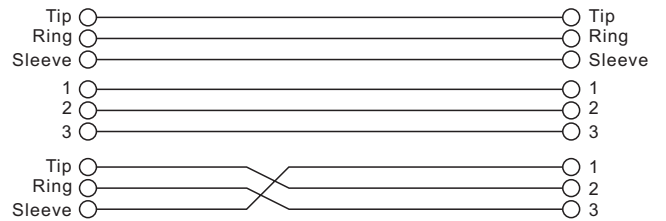
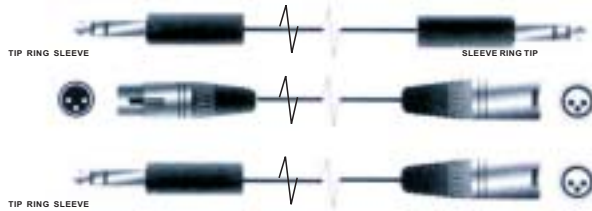

• Unbalanced

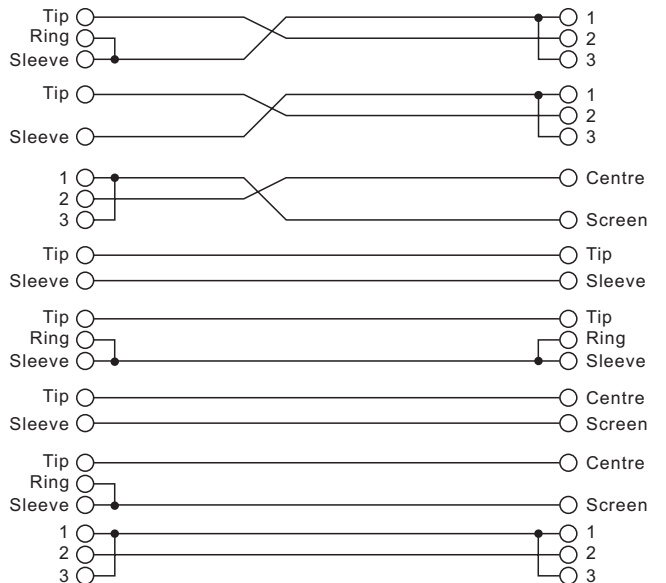
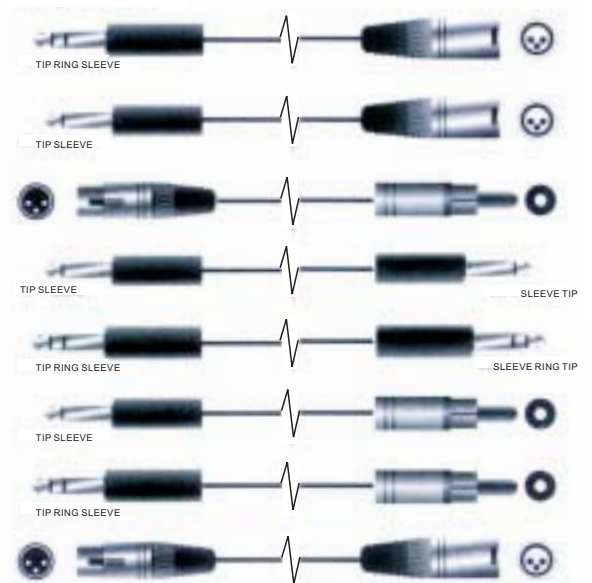

4.3. Rack Mounting

The most secure mounting is on a universal rack shelf available from various rack manufactures or your music dealer. The X23SW Active Crossover fits into one standard 19" rack unit of space. Please allow at least an additional 4" depth for the connectors on the rear panel. Be sure that there is enough air space around the unit for sufficient ventilation and please do not place the X23SW Active Crossover on high temperature devices such as power amplifiers etc. to avoid overheating.

5. APPLICATION

5.1 X23SW 2-Way Stereo

Present your X23SW Active Crossover in a 2-way stereo application, please connect the unit in your system as the following illustration step by step:

1. Plug the Left line-in into INPUT 1 and the Right line-in into INPUT 2.
2. Connect the LOW OUT 1 to the Left input of the Low frequency amplifier, and the LOW OUT 2 to the Right input of the Low frequency amplifier.
3. Connect the HIGH OUT 1 to the Left input of the High frequency amplifier, and the HIGH OUT 2 to the Right input of the High frequency amplifier.
4. Connect the SUB woofer OUTPUT TO the subwoofer amplifier via this unbalanced 1/4" output jack.

TYPICAL SET-UP

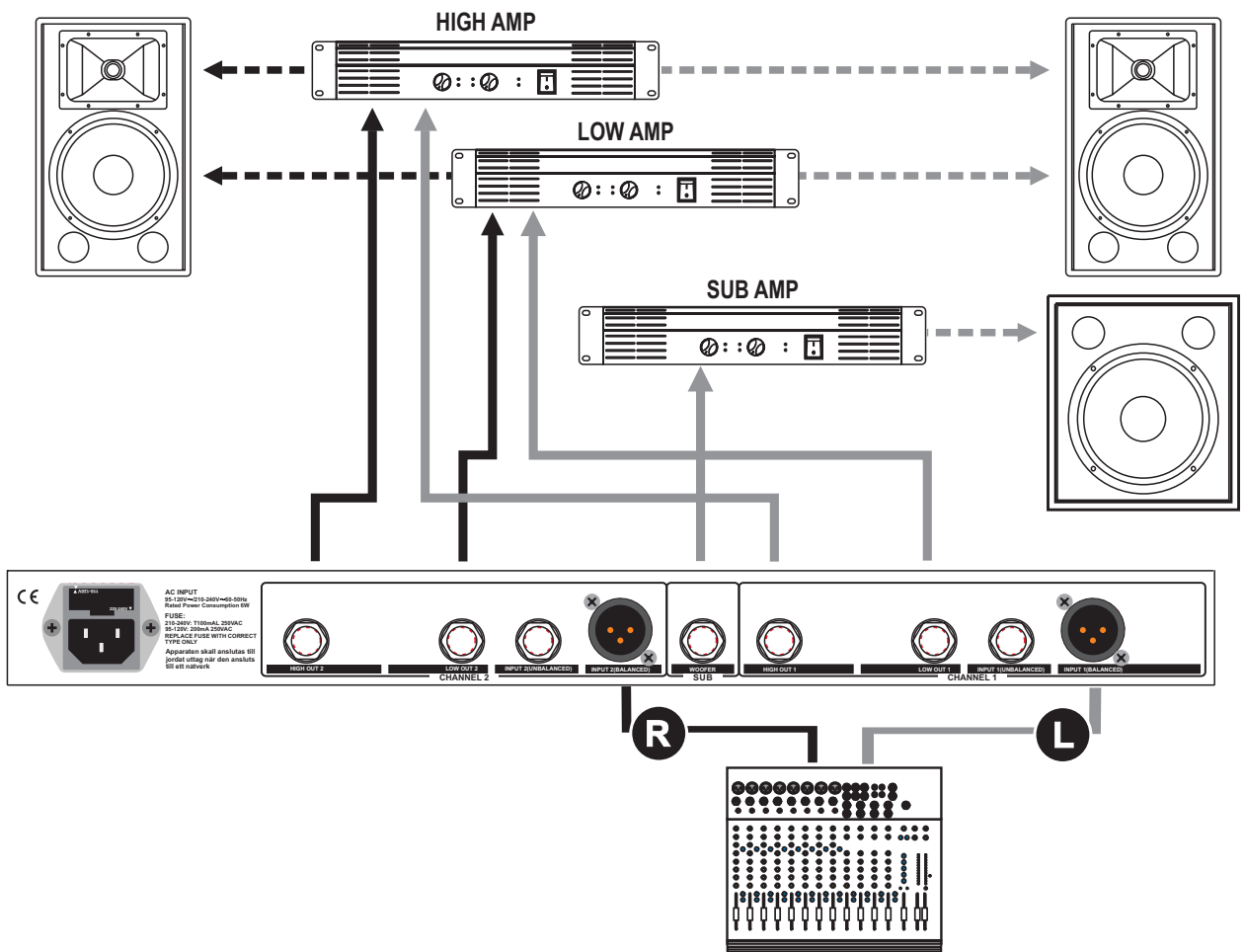

6. TECHNICAL SPECIFICATIONS

Electrical	
Subwoofer Frequency Range	50Hz ~ 250Hz
Low - High Frequency Range	250Hz ~ 6KHz
THD	<0.05%
S/N Ratio	>95dB
Controls	
Input Level	Continuouliy variable
Output Level	Sub, Low. High continuously variable
Low Cut	Front panel switches
Phase	Front panel switches
Power Supply	
Connector type	3-pole IEC , grounded
Type	Servo controlled, stabilized
Mains supply	95-120V~/210-240V~,60-50Hz
Power Rating	6W
Physical	
Dimensions	483(W)×194.5(D)×44(H)mm (19"×7.7"×1.7")
Weight	2.95 Kg(6.50lb)

7. WARRANTY

1. WARRANTY REGISTRATION CARD

To obtain Warranty Service, the buyer should first fill out and return the enclosed Warranty Registration Card within 10 days of the Purchase Date.

All the information presented in this Warranty Registration Card gives the manufacturer a better understanding of the sales status, so as to purport a more effective and efficient after-sales warranty service. Please fill out all the information carefully and genuinely, miswriting or absence of this card will void your warranty service.

2. RETURN NOTICE

- 2.1 In case of return for any warranty service, please make sure that the product is well packed in its original shipping carton, and it can protect your unit from any other extra damage.
- 2.2 Please provide a copy of your sales receipt or other proof of purchase with the returned machine ,and give detail information about your return address and contact telephone number .
- 2.3 A brief description of the defect will be appreciated.
- 2.4 Please prepay all the costs involved in the return shipping, handling and insurance.

3. TERMS AND CONDITIONS

- 3.1 ▲LTO warrants that this product will be free from any defects in materials and/or workmanship for a period of 1 year from the purchase date if you have completed the Warranty Registration Card in time.
- 3.2 The warranty service is only available to the original consumer, who purchased this product directly from the retail dealer, and it can not be transferred.
- 3.3 During the warranty service,▲LTO may repair or replace this product at its own option at no charge to you for parts or for labor in accordance with the right side of this limited warranty.
- 3.4 This warranty does not apply to the damages to this product that occurred as the following conditions:
 - Instead of operating in accordance with the user's manual thoroughly, any abuse or misuse of this product.
 - Normal tear and wear.
 - The product has been altered or modified in any way.
 - Damage which may have been caused either directly or indirectly by another product / force / etc
 - Abnormal service or repairing by anyone other than the qualified personnel or technician.And in such cases, all the expenses will be charged to the buyer.
- 3.5 In no event shall ▲LTO be liable for any incidental or consequential damages. Some states do not allow the exclusion or limitation of incidental or consequential damages, so the above exclusion or limitation may not apply to you.
- 3.6 This warranty gives you the specific rights, and these rights are compatible with the state laws, you may also have other statutory rights that may vary from state to state.

SEIKAKU TECHNICAL GROUP LIMITED
No. 1, Lane 17, Sec. 2, Han Shi West Road, Taichung 40151 Taiwan
<http://www.altoproaudio.com> Tel: 886-4-22313737
email: alto@altoproaudio.com Fax: 886-4-22346757

All rights reserved to ALTO. All features and content might be changed without prior notice. Any photocopy, translation, or reproduction of part of this manual without written permission is forbidden. Copyright © 2005 SEIKAKU GROUP